

**GOODWE**



# INSTALLATION MANUAL

**GOODWE PVBM**

UP TO A SUSTAINABLE FUTURE

**GALAXY PLUS**

BMT-G4/088A

# CONTENT

**1**

DESCRIPTION OF THE  
MAIN STRUCTURE OF  
GALAXY PLUS

**P3****2**

INSTALLATION  
TOOLS

**P4****3**

PRE-INSTALLATION  
INSPECTION WORK OF  
GALAXY PLUS

**P5****4**

INSTALLATION OF  
GALAXY PLUS

**P6****5**

ELECTRICAL  
INSTALLATION

**P17****6**

ELECTRICAL  
CONSTRUCTION  
PROCESS

**P21****7**

OPERATION AND  
MAINTENANCE

**P24****8**

CAUTIONS

**P25**

## 1

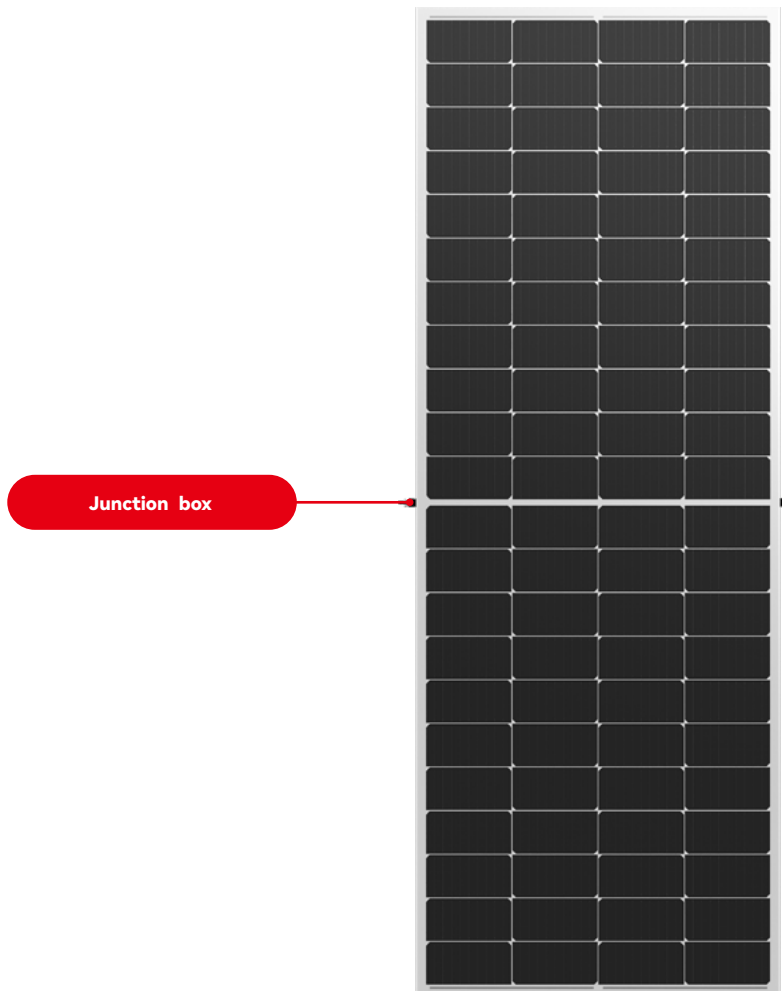
DESCRIPTION OF THE MAIN STRUCTURE OF  
GALAXY PLUS

Installation Altitude : <2000m

Fire Protection Level : CLASS C

(According to the standard of IEC 61730-2-MST23)

Protection Level : Level II

Maximum Mechanical load : Front 2400Pa ; Back 2400Pa

# 2

## INSTALLATION TOOLS

Please refer to the BOM list for detailed parts information, the following quantity represents the number of accessories matched with each piece of product.

### 2.1 MOUNTING ACCESSORIES LIST



Size

2390×18.7×22.5mm

Material

PPO

Mounting accessories

Support tube

### 2.2 CONSTRUCTION TOOLS LIST

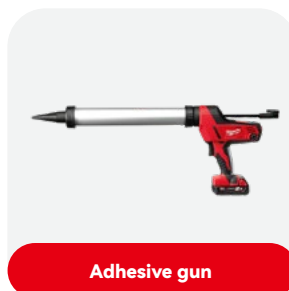
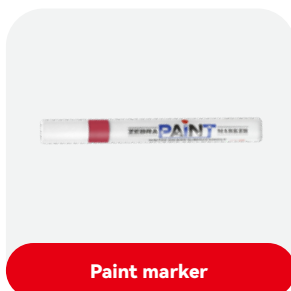

PS: This list only shows the main tools for installing the Galaxy Plus, if it involves the removal or installation of the roof bracket, please refer to the preparation of the building work.

### 2.3 ELECTRICAL TOOLS LIST

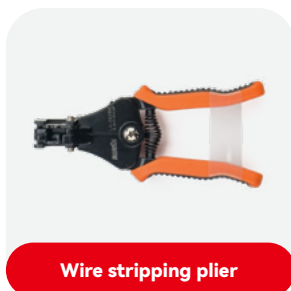

## 3

## PRE-INSTALLATION INSPECTION WORK OF GALAXY PLUS

**WARNING**

- Please use insulated tools to reduce the risk of electric shock.
- Please adopt appropriate protective measures (non-slip gloves, work clothes, etc.) to avoid direct contact with 30V DC or higher, and avoid direct contact with sharp edges during installation
- Please do not wear metal ornaments during installation to avoid poking through the Galaxy Plus and causing electric shock hazards.
- DO NOT install the product in rainy weather or strong wind.
- DO NOT allow children or unauthorized personnel to approach the installation area or the storage area of Galaxy Plus.
- During installation or wiring of Galaxy Plus, if the circuit breaker and overcurrent protection circuit breaker cannot be turned on or the inverter cannot be turned off, then use an opaque material to cover the array of Galaxy Plus to stop the power output.
- Do not use or install Galaxy Plus that have been damaged.
- If the surface material is damaged or worn, direct contact with the surface of Galaxy Plus may result in electric shock.
- Do not attempt to repair any part of the Galaxy Plus.
- The lid of the junction box should be kept closed all the time.
- Do not disassemble, modify, or move any part of the Galaxy Plus.
- Do not artificially concentrate light on Galaxy Plus.
- It is important to note that only one piece of product can be moved in a single operation when installing the Galaxy Products.

**ATTENTION**

- Before installing Galaxy Plus, the relevant authorities should be contacted to obtain information about the installation site and construction permits, and the requirements for installation and inspection should be observed.
- Check the applicable building codes to ensure that the building and its structure (roof, exterior façade, load bearing, etc.) in which Galaxy Plus are to be installed have adequate load-bearing capacity.
- Ensure that Galaxy Plus are installed on a fireproof roof.
- Galaxy Plus are compliant with Safety Class II. These Galaxy Plus can be used in systems where the public is likely to be exposed to voltages greater than 50V or power greater than 240W.
- The installation surface should be flat and free of pits or bumps.

- Galaxy Plus must not be installed near flames or combustible objects.
- Galaxy Plus must not be exposed to artificial sources of concentrated light.
- Galaxy Plus must not be immersed in water (pure or salt water), installed in environments that are permanently wet (pure or salt water) (e.g., fountains, waves, etc.) or in locations where water is likely to accumulate (e.g., potholes, drainage inlets, etc.).
- There is a risk of corrosion if Galaxy Plus are placed in salt spray (i.e., marine environments) or environments containing sulfur (i.e., sulfur-containing sources, volcanoes, etc.).
- Ensure that Galaxy Plus meet the overall technical requirements of the system.
- Ensure that other system components do not cause damaging mechanical or electrical performance effects on Galaxy Plus.
- It is allowed to connect Galaxy Plus in series to increase the voltage or in parallel to increase the current. When connected in series, the positive terminal of the Galaxy Plus is connected to the next negative terminal. When connected in parallel, the positive terminal of the Galaxy Plus is connected to the positive terminal of the next Galaxy Plus.
- To avoid (or minimize) the mismatch effect of the array, it is recommended to connect Galaxy Plus with similar electrical properties on the same string.
- To reduce the risk of indirect lightning strikes, the system should be designed to avoid the creation of loops.
- Galaxy Plus should be securely fastened so that they can withstand all possible loads, including wind and snow loads.
- When installing Galaxy Plus, it is strictly prohibited to step on, twist or collide with them.
- Secondary handling should be avoided as much as possible during the installation of Galaxy Plus.
- Please ensure that the installation location of Galaxy Plus is free from shading all year round, as shadows can cause a decrease in the power generation of Galaxy Plus. Hot spots and long-term heat generation from diodes caused by frequent shading of Galaxy Plus can affect the service life of Galaxy Plus.

## 4

## INSTALLATION OF GALAXY PLUS

### 4.1 STORAGE AND UNPACKING

- To ensure the safety of Galaxy Plus during transportation, it is better to open the packaging box of Galaxy Plus after reaching the installation site.
- Check whether the box is damaged before unpacking.
- It is advised that unpackers wear non-slip gloves in advance.
- Galaxy Plus should be stored in a dry and ventilated environment.
- Galaxy Plus must be shipped in the boxes provided by GOODWE and should be stored in the original boxes before installation. Please protect the packaging from damage. Follow

the recommended unpacking procedure to open Galaxy Plus packaging. Careful handling is required during unpacking, transportation, and storage.

- DO NOT apply excessive loads or twist Galaxy Plus.
- DO NOT use wires or junction boxes to carry Galaxy Plus.
- DO NOT stand, climb, walk or jump on Galaxy Plus.
- DO NOT allow Galaxy Plus to come into contact with sharp objects; scratches can directly affect the safety of Galaxy Plus.
- DO NOT place Galaxy Plus in an environment that is not reliably supported or not fixed.
- Changing the wiring of the bypass diode is prohibited.
- All electrical connectors need to be kept clean and dry.
- Galaxy Plus are not allowed to be stacked flat and the quantity should not exceed 3 pieces. The junction box shall not be in direct contact with the front side.

#### 4.2 CHECKING

- Please check whether the surface of Galaxy Plus is damaged, if there is damage or wear on the surface of the products, please do not use the product.
- Please check whether the junction box, connectors and cables are damaged. Please do not use the product if there is damage.
- DO NOT apply adhesives, paint, label or any other product on the surface of Galaxy Plus.

#### 4.3 ROOF SUBSTRATE REQUIREMENTS

- The base layer application scenario includes colour steel tile roof or flat roof.
- The surface of the substrate should be uniform, flat and without sharp bumps or burrs, etc.
- For colour steel tile roof, the rib spacing should be less than 500mm, with a height difference between the rib and valley more than 25mm ( 25mm is recommended, actual installation requirements should be subject to the terms of the local inspector), and rib width more than 23mm. (Figure 1)

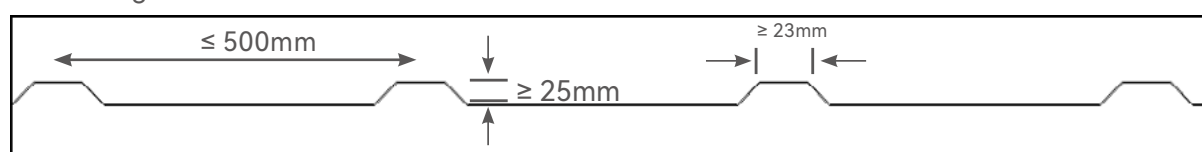

FIGURE 1

#### 4.4 CONSTRUCTION AMBIENT TEMPERATURE REQUIREMENTS

- -10° C to +60° C for base construction and ambient construction.
- >5° C for contact adhesives/cleaners etc.
- It may be mandatory to take measures to ensure safety when working at ambient temperatures below 5° C as required by relevant national codes.

#### 4.5 POSITIONING

- Measure the roof and determine the position of Galaxy Plus according to the design drawings.

## 4.6 CARRYING

- To avoid damaging the cells, two workers are required to lift the four corners of the Galaxy Plus (avoiding touching the position of the cells) at the same time when carrying it.
- The downward bending distance of Galaxy Plus should not exceed 300mm when handled manually. Please carefully position Galaxy into predestined location.
- Galaxy Plus should be carried upright as much as possible when handled manually. Do not twist the product during transportation and avoid front-facing products.
- Care is required during the handling of Galaxy Plus to avoid them bumping into the ground or other sharp, hard objects.

## 4.7 INSTALLATION

### Installation of Galaxy Plus by adhesive on colour steel tile roof.

Rule of applying structural adhesive:

- Galaxy Plus are bonded to the colour steel tile by structural adhesive, which needs to meet the requirements for adhesive strength and pass reliability testing. Each product should be equipped with no less than 6 strips of structural adhesive on the back (Figure 2) and the spacing between each strip of structural adhesive should be as evenly distributed as possible. The distance between two strips of structural adhesive should not be greater than 500mm.

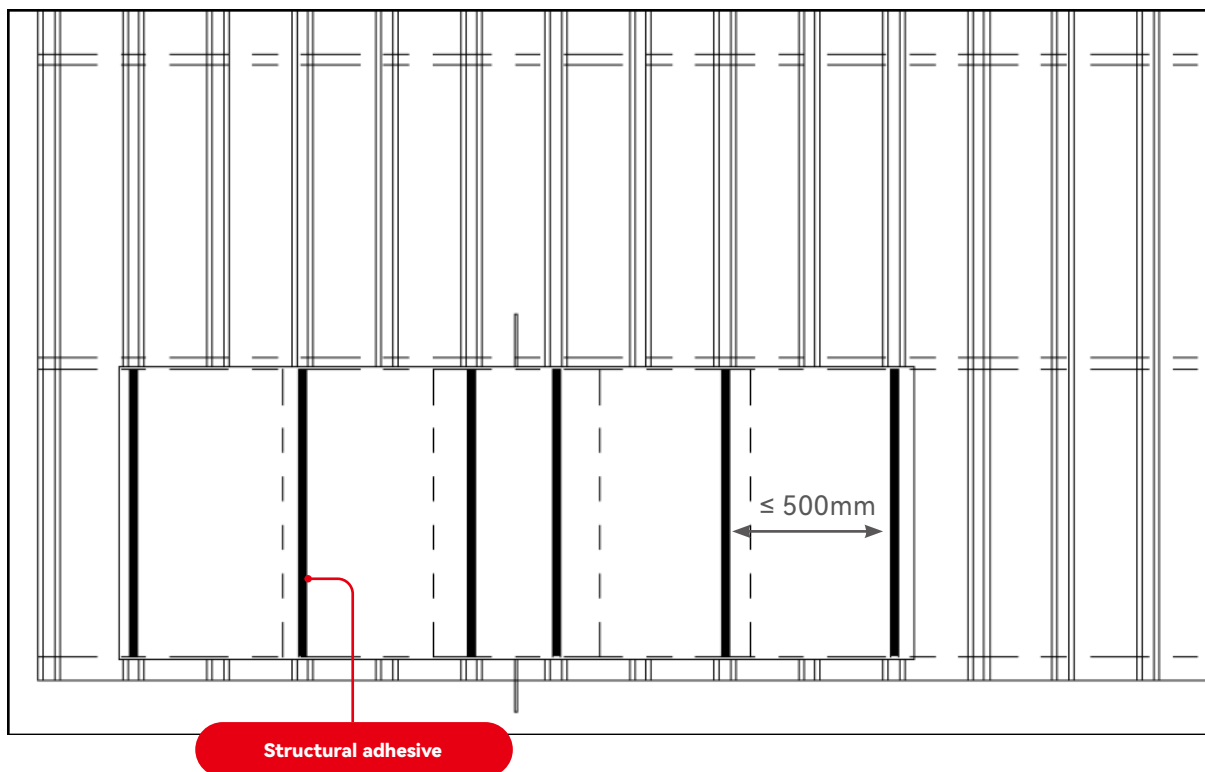

**FIGURE 2**

- The distance that the product overhangs beyond the rib at each end should not exceed 50mm. (Figure 3)



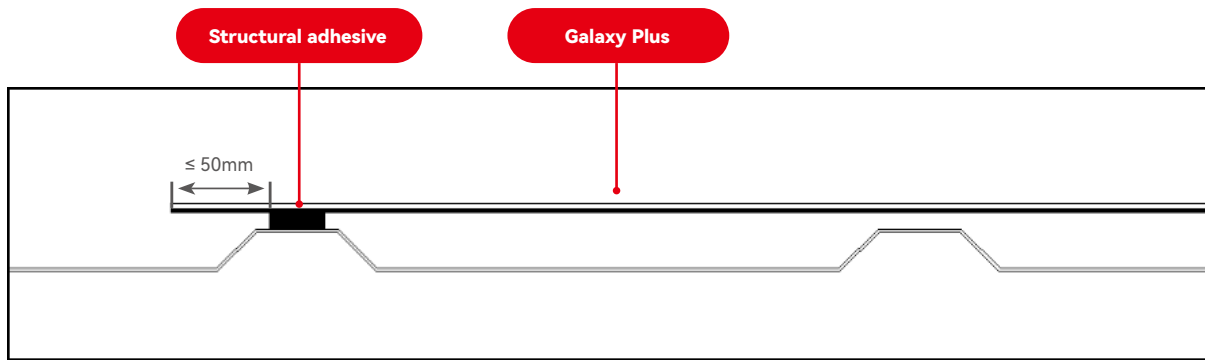

FIGURE 3

- The cross-section of the structural adhesive should be a semi-circular shape with a width of more than 18mm and a height of more than 6mm. (Figure 4)

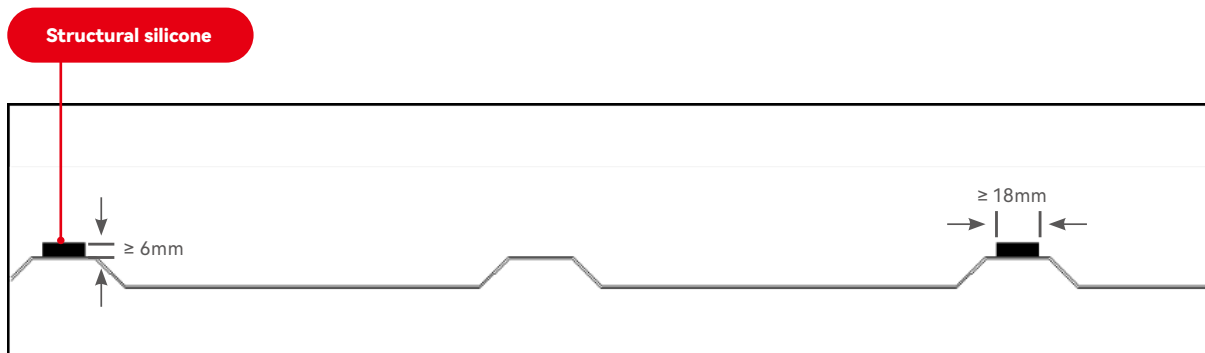

FIGURE 4

- The length of each section of structural adhesive should be 767mm, with a 5mm indentation at each end compared to the long edge of the Galaxy Plus (Figure 5).

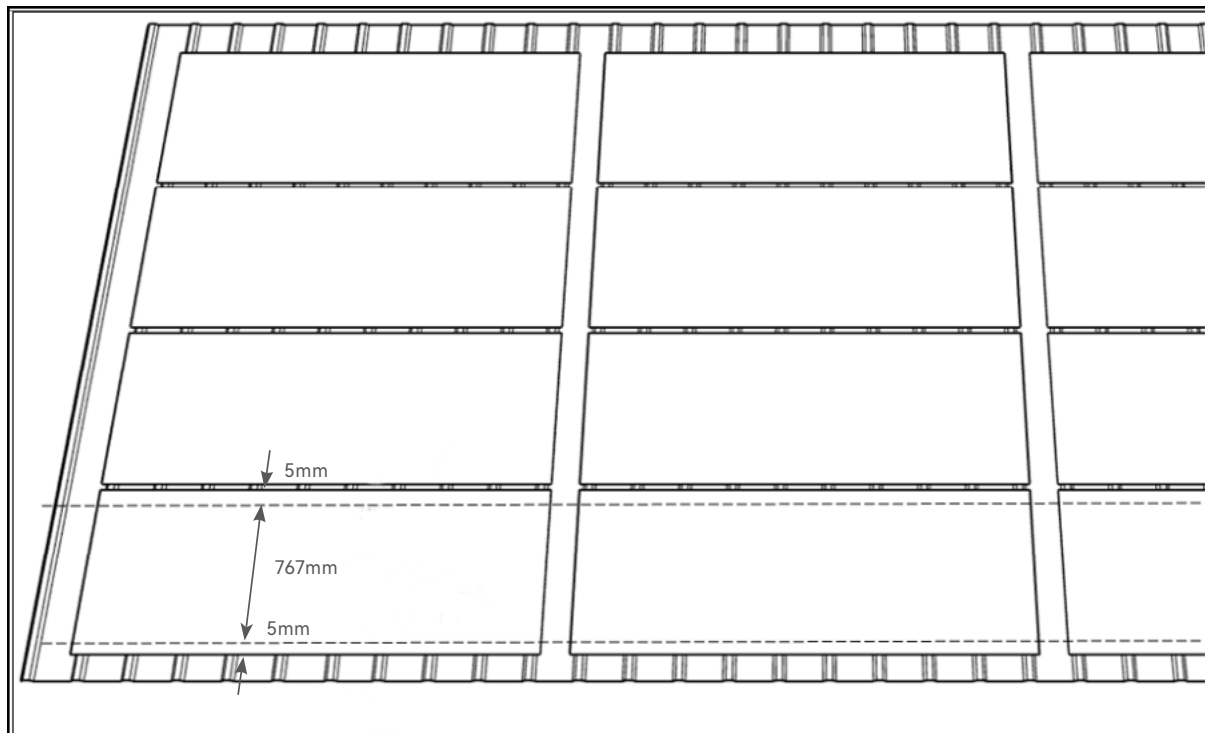
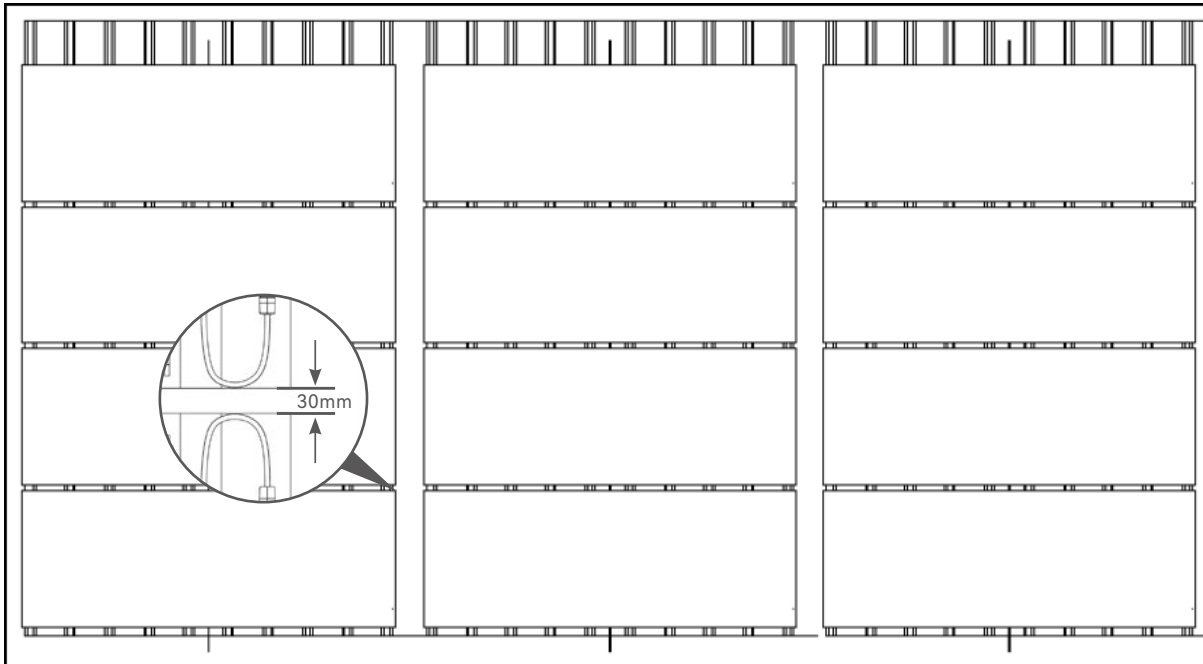

FIGURE 5

- A distance of 30mm ( $\pm 5$ mm) should be left between two adjacent products and a maintenance access path of sufficient width should be provided between two rows of products. (Figure 6).



**FIGURE 6**

Construction steps:

- Before product construction, all materials and adhesives to be processed must be stored for at least 24 hours under equal conditions (such as 5° C - 40° C) and protected from sunlight, rainwater and other weather factors.
- Clean the roof substrate. The roof surface must be clean, dry and free from oil, dust and other waste pollution. Every step in the construction process must prevent secondary pollution of the cleaned material surface. If pollution occurs, the surface must be re-cleaned.
- The on-site construction should meet the requirements of the selected structural adhesive for the construction environment, construction technology and other construction requirements.
- The adhesive position should be determined by the chalk line, and the structural adhesive should be applied according to the gluing rules at the location where the product needs to be installed. (Figure 7)

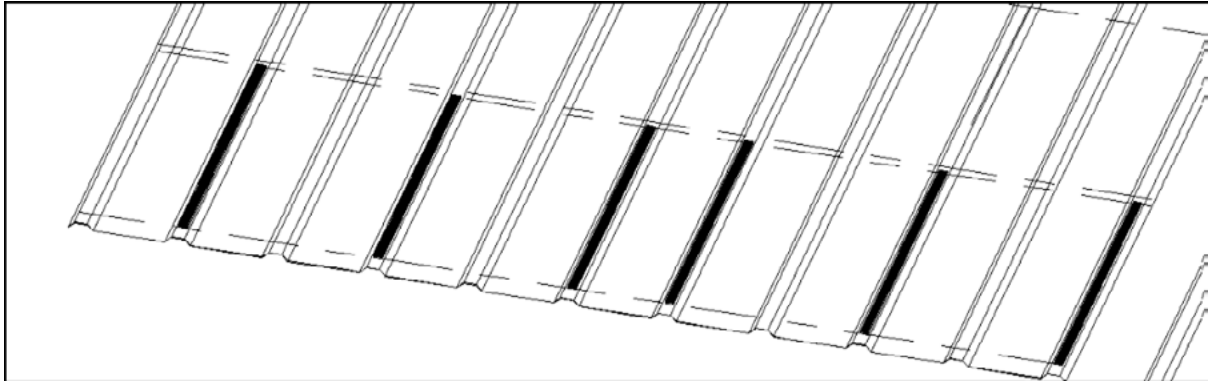

**FIGURE 7**

- Two people should grab the four corners of the Galaxy Plus, lift and carry it vertically, and then adhere the Galaxy Plus face-up to the colour steel tile. The end of the structural adhesive should be indented by 5mm compared to the long edge of the product (Figure 8).

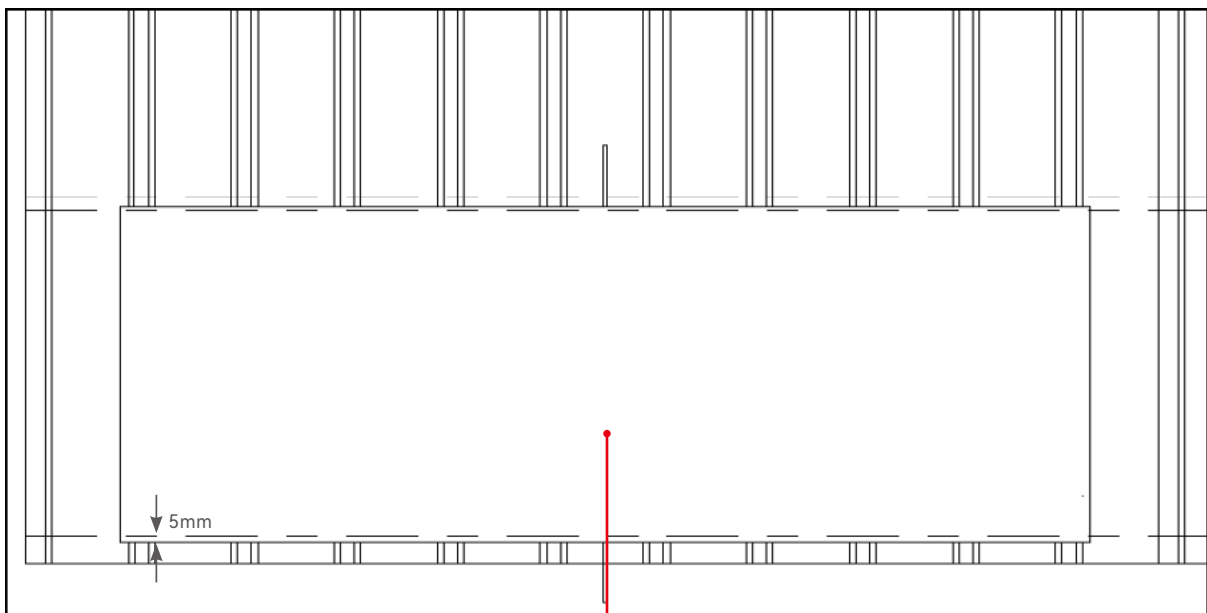

Galaxy Plus

**FIGURE 8**

- Use soft tools to gently press the front side of the product, making the Galaxy Plus bonded to the rib of the colour steel tile roof firmly, with a glue thickness of 2~3mm.
- Repeat the above steps and complete the installation of the remaining products.

**Installation of Galaxy Plus by adhesive on the flat roof**

Rule of applying structural adhesive:

- Galaxy Plus are installed on the flat roof by support tubes, using structural adhesive which needs to meet the requirements for adhesive strength and pass reliability testing. The support tubes are glued on both sides, respectively bonded to the base of the flat roof and the back of the product. The spacing is as follows. (Figure 9) The distance between two strips of structural adhesive should not be greater than 500mm.

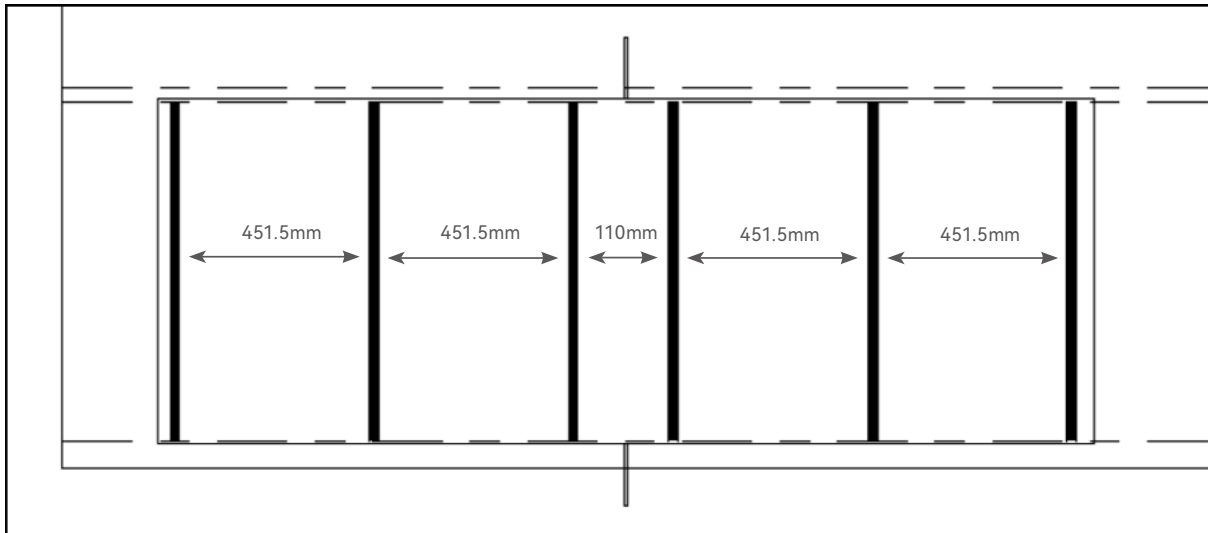

**FIGURE 9**

- The distance that the product overhangs beyond the rib at each end should not exceed 50mm. (Figure 10)

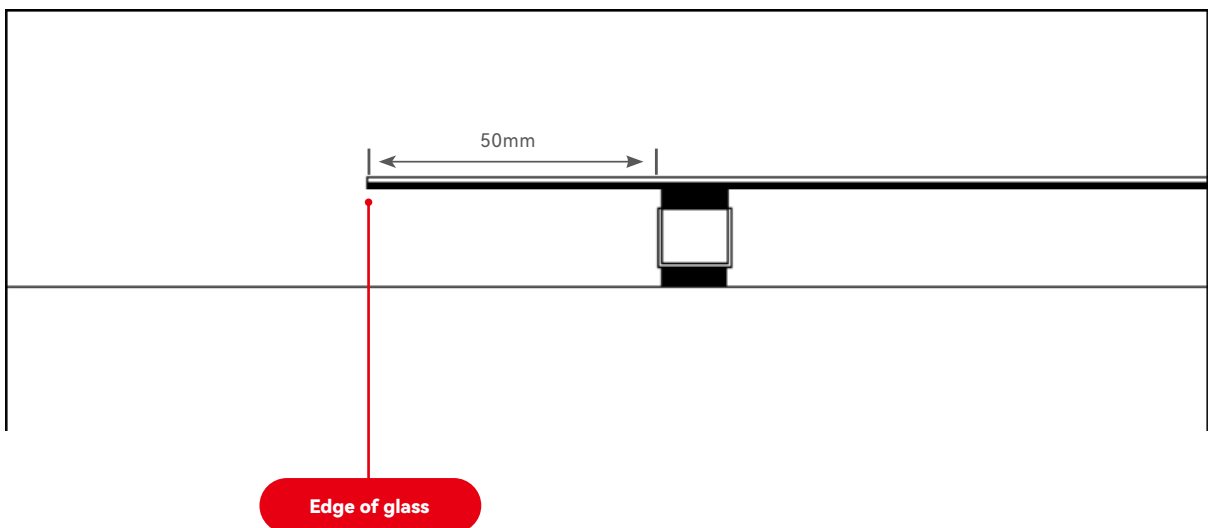

**FIGURE 10**

- The cross-section of the structural adhesive should be a semi-circular shape with a width of more than 18mm and a height of more than 6mm. (Figure 11)

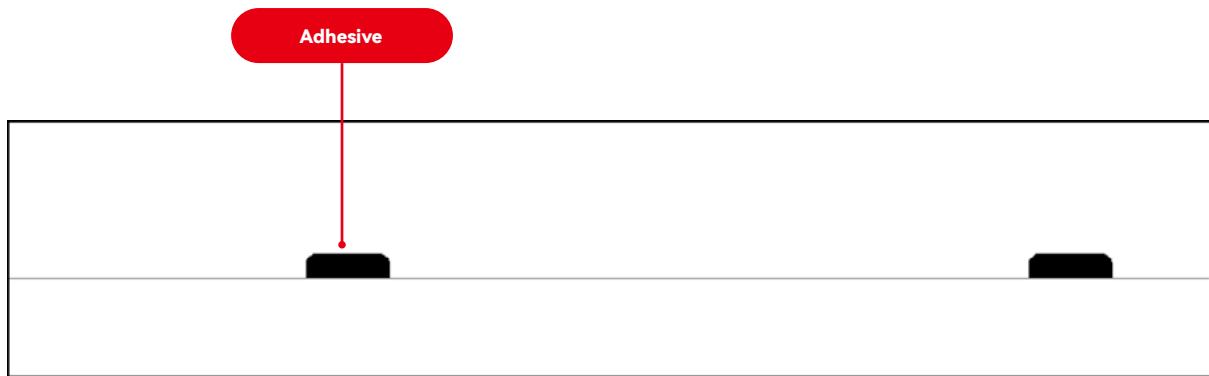

**FIGURE 11**

● The length of the support tube is 2390mm, which is the same length as the gluing of the substrate underneath. The length of the structural adhesive between the square tube and the upper product is 767mm, and the two ends are indented 5mm from the long side of the Galaxy Plus; (Figure 12)

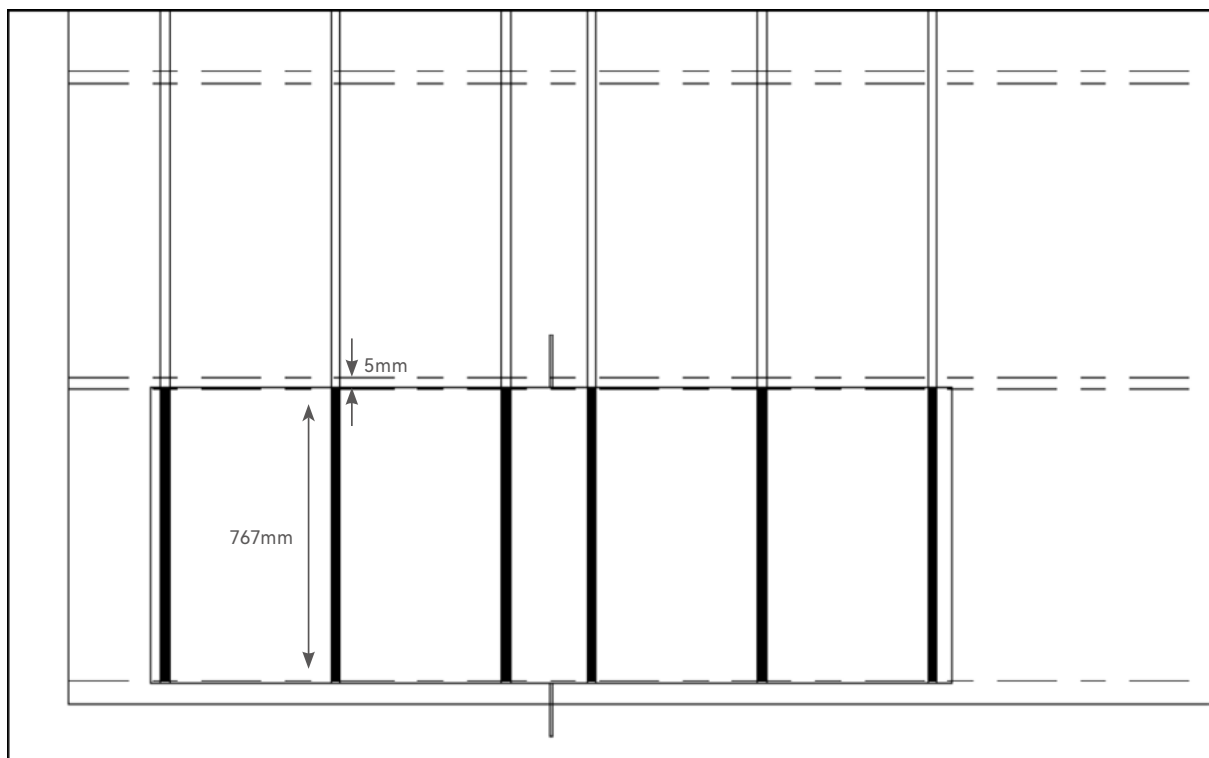

**FIGURE 12**

● There is a grounding hole on the tube, and one side of the grounding hole should not face the backplane to prevent the burrs on the grounding hole from scratching and piercing the backplane. The two tubes in the middle (Figure 13) are erected and installed at a higher installation height, and the other tubes on both sides (Figure 14) are installed flat and installed at a lower height, as shown below (Figure 15) ;

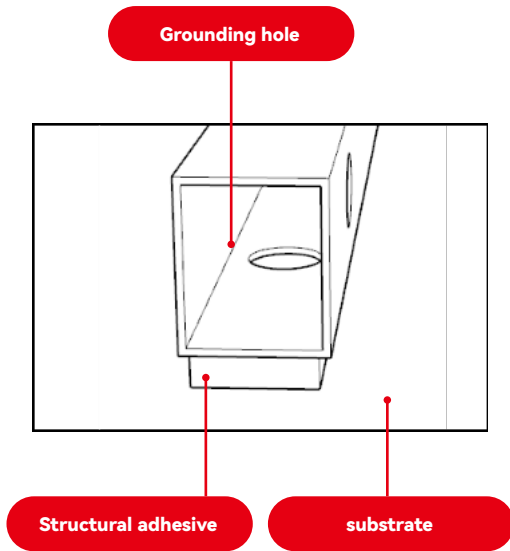

FIGURE 13

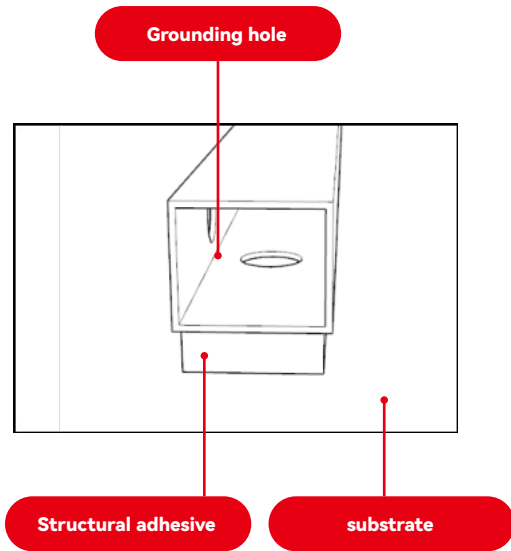

FIGURE 14

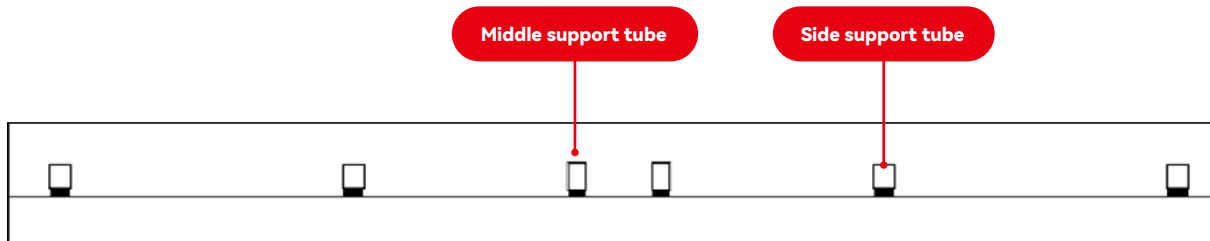

FIGURE 15

● A distance of 30mm( $\pm 5$ mm) should be left between two adjacent products and a maintenance access path of sufficient width should be provided between two rows of products. (Figure 16).

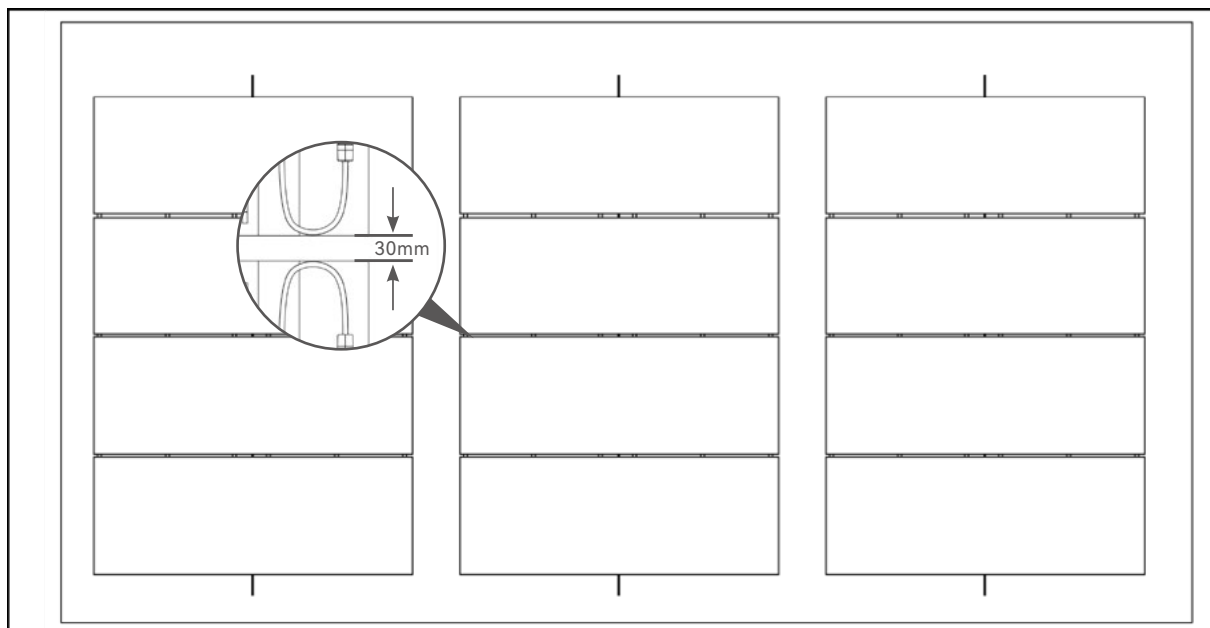
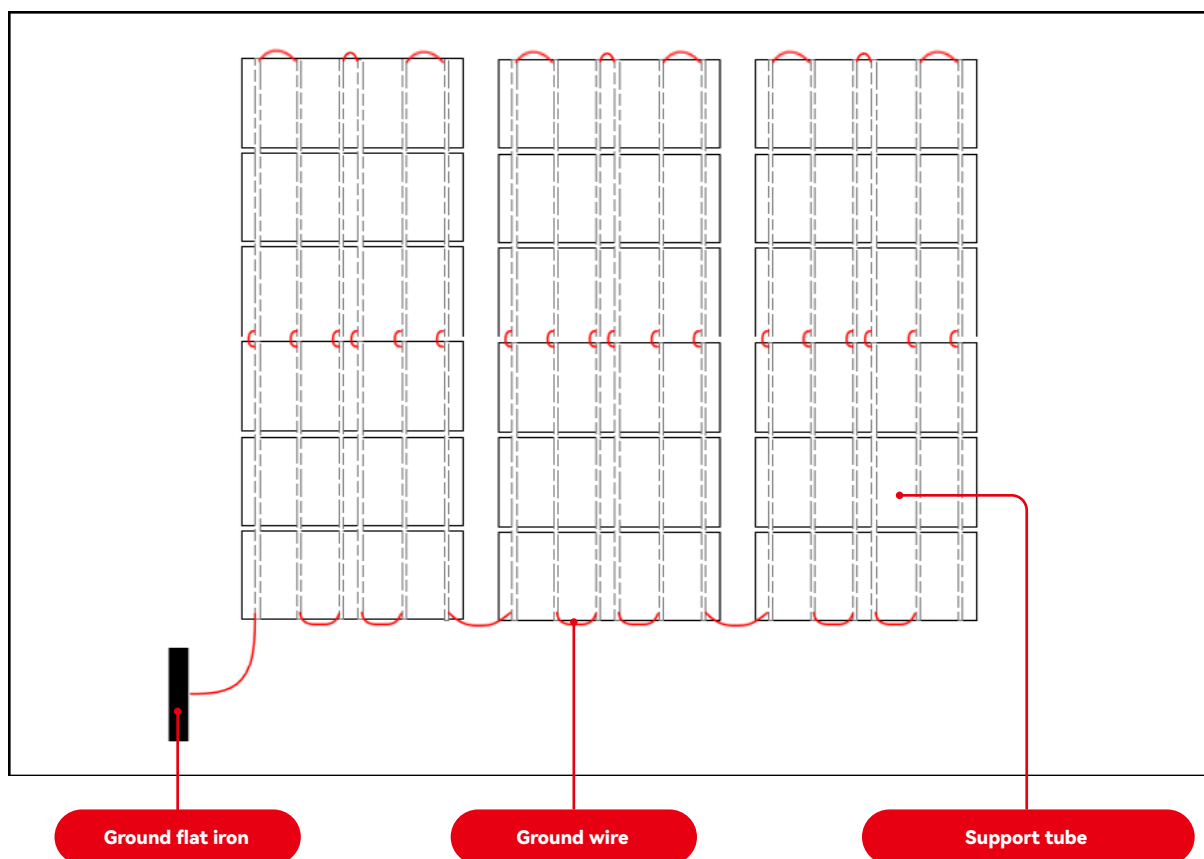

FIGURE 16

Construction steps:

- Before product construction, all materials and adhesives to be processed must be stored for at least 24 hours under equal conditions (such as 5° C - 40° C) and protected from sunlight, rainwater and other weather factors.
- Clean the roof substrate. The roof surface must be clean, dry and free from oil, dust and other waste pollution. Every step in the construction process must prevent secondary pollution of the cleaned material surface. If pollution occurs, the surface must be re-cleaned.
- The on-site construction should meet the requirements of the selected structural adhesive for the construction environment, construction technology and other construction requirements.
- The adhesive position of the support tube should be determined by the chalk line, and the structural adhesive should be applied on the substrate according to the gluing rules at the location where the product needs to be installed. Then install the tubes.
- Install the grounding wire, so that the support tubes under all products are connected into a conductive path to lead out the bus, and connected to the grounding flat iron, which is connected to the ground pile. The depth of the ground pile is greater than 1.5m, and the grounding resistance is less than 4Ω. (Figure 17)



**FIGURE 17**

- The adhesive position on the support tube should be determined by the chalk line, and the structural adhesive should be applied according to the gluing rules at the location where the product needs to be installed. (Figure 18)

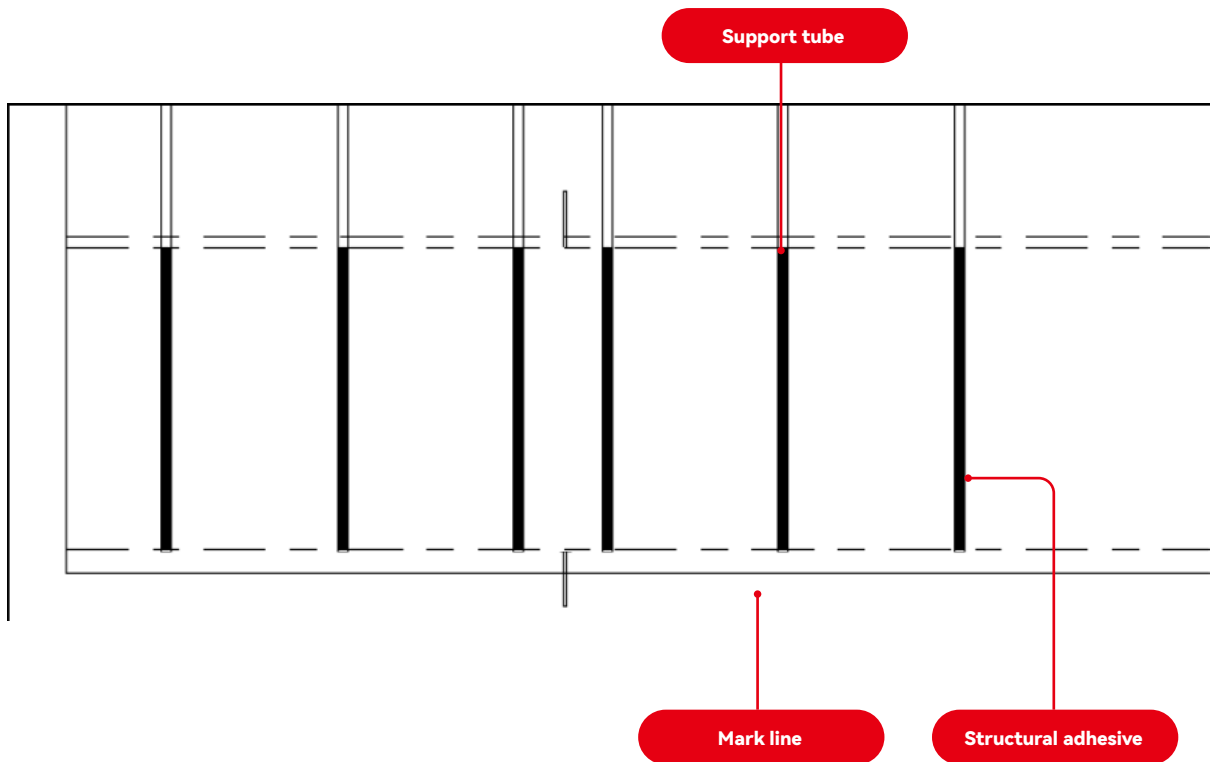

FIGURE 18

- Two people should grab the four corners of the Galaxy Plus, lift and carry it vertically, and then adhere the Galaxy Plus face-up to the support tube. The end of the structural adhesive should be indented by 5mm compared to the long edge of the product (Figure 19).



FIGURE 19



- Use soft tools to gently press the front side of the product, making the Galaxy Plus bonded to the support tube firmly, with a glue thickness of 2~3mm.
- Repeat the above steps and complete the installation of the remaining products.

# 5

## ELECTRICAL INSTALLATION

### 5.1 ELECTRICAL PERFORMANCE

- The nominal values of electrical performance parameters such as  $I_{sc}$ ,  $V_{oc}$  and  $P_{max}$  of Galaxy Plus have an error of  $\pm 3\%$  from those under standard test conditions. Standard test conditions for Galaxy Plus: irradiance 1000 W/m<sup>2</sup>, cell temperature 25° C, atmospheric mass AM 1.5.
- When Galaxy Plus are connected in series, the total voltage is the sum of the voltage of every single Galaxy Plus in the string, and when Galaxy Plus are connected in parallel, the final current is the sum of the current of every string of Galaxy Plus. (Figure 20) Galaxy Plus of different electrical performance models should not be connected in one string.

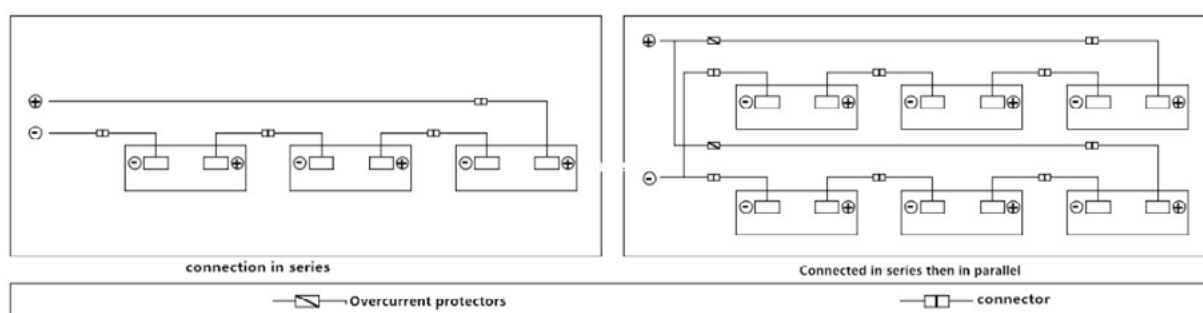

**FIGURE 20 SERIES-PARALLEL ELECTRICAL DIAGRAM**

- The maximum number of single strings of Galaxy Plus that can be connected in series must be calculated in accordance with the requirements of local electrical requirements and regulations. and the value of its open-circuit voltage at the lowest expected local temperature conditions must not exceed the maximum system voltage value specified for Galaxy Plus (maximum system voltage for the products is DC1000V/DC1500V - the actual system voltage is designed according to the selection of the product models and inverters) and other values required for DC electrical components.
- The open circuit voltage correction factor can be calculated with the following formula:  $C_{Voc} = 1 - \beta V_{oc} \times (25 - T)$  where T is the minimum ambient temperature expected at the system installation location and  $\beta$  (%/° C) is the temperature coefficient of the open circuit voltage of selected Galaxy Plus (refer to the corresponding Galaxy Plus parameter table).
- If a reverse current exceeding the maximum fuse current of the Galaxy Plus may pass through the Galaxy Plus, an overcurrent protection device of the same size must be used to

protect the product. If the number of parallel connections is more than or equal to 2 strings, there must be an overcurrent protection device on each string of the products, the Figure 20.

## 5.2 CABLE AND CONNECTING WIRES

- Galaxy Plus shall be connected by using IP67-rated junction boxes, which shall provide safe protection for the conductors and their corresponding connections, and accessible protection for non-insulated live parts. The junction box consists of a connected cable and IP67 rated connectors to facilitate the series connection between Galaxy Plus. A single product has two separate wires connected to two separate junction boxes, one positive and one negative. Two Galaxy Plus can be connected in series by inserting the positive connector into the socket of the negative connector of the adjacent product.
- Use dedicated solar cables and appropriate connectors (wires should be encased in age-resistant conduit or, if exposed to air, should be age-resistant themselves) and ensure that the cables are electrically and mechanically sound, in accordance with local fire, building and electrical codes. Installers should only use single-core solar cables, 2.5-16mm<sup>2</sup> (5-14 AWG), 90° C rated, with appropriate insulation to withstand the maximum possible system open circuit voltage (as approved by EN 50618). Appropriate wire sizes need to be selected to minimize voltage drop. All wiring and electrical connections comply with the requirements of the appropriate National Electrical Code or standard. Avoid mechanical damage to the cable or Galaxy Plus when the cable is secured to the bracket. Do not press the cable with force. The cable shall be secured to the bracket by specially designed aging-resistant cable ties and wire clips. Although the cable is resistant to aging and water, it should be protected from direct sunlight and rain. The minimum bending radius of the cable should be 43mm.



FIGURE 21 MINIMUM BENDING RADIUS OF THE CABLE

## 5.3 CONNECTOR

- Please keep the connector dry and clean, and make sure that the nut of the connector is tightened before connecting. Do not connect the connector when it is wet, dirty or in other unfavorable conditions. If the connector is not connected properly to the other polarity, the connector is not waterproof. It is necessary to connect or take appropriate measures to avoid the infiltration of water vapour and dust as soon as possible after the module is mechanically

installed on the roof. Avoid having connectors exposed to direct sunlight and immersed in water. Avoid having connectors falling on the ground or on the roof. Incorrect connections may produce arcing and electric shock. Make sure all electrical connections are secure. Make sure that all connectors with locking are fully connected.

It is not recommended that connectors of different models be connected and used together. installed to the roof. Avoid having connectors being exposed to direct sunlight and immersed in water. Avoid having connectors falling on the ground or on the roof. Incorrect connections may produce arcing and electric shock. Make sure all electrical connections are secure. Make sure that all connectors with locking are fully connected.

- It is not recommended that connectors of different models be connected and used together.

#### **5.4 BYPASS DIODE**

● The cell strings within a solar module are protected by bypass diodes in parallel and encapsulated in a junction box. When a hot spot phenomenon occurs locally in a module, the diode will activate so that string current no longer flows from the hot spot cells, thus limiting module heating and performance loss. Note that the bypass diode is not an overcurrent protection device. Contact the installer or system maintainer when a diode failure is detected or suspected. Do not attempt to open the module's junction box by yourself.

#### **5.5 ELECTRICAL REQUIREMENTS FOR THE INSTALLATION OF GALAXY PLUS**

Inspection before installation

- No visible defects.
- Models and specifications should meet the requirements of the design drawings.
- Accessories and spare parts are available;

Preparation of main tools

- Multimeter: For measuring the open-circuit voltage of Galaxy Plus.
- Angle measuring instrument, level, etc.: measuring the installation angle of the Galaxy Plus array.
- Installation tools and spare parts are covered in Section 2.

#### **5.6 MATERIAL PREPARATION**

Please check whether the type and quantity of the arriving material are correct against the material list in the configuration sheet.

Galaxy Plus Electrical Wiring Requirements.

- Wiring with clear, unambiguous and easily understood wire number identification.
- Jumper cable diameter must exceed the original Galaxy Plus cable diameter, and flame retardant and insulation performance should also be no less than that of the Galaxy Plus cable.
- Galaxy Plus should be connected in the shortest cable run possible.
- When Galaxy Plus require long straddle connections, try to minimize the difference in the

total length of each set of string-connected cables.

- The wiring terminals should be in good contact. When connecting each part of the Galaxy Plus in series, it is best to test once each section is completed with a multimeter-to-string connectivity.

Electrical wiring method of Galaxy Plus

- Wiring in accordance with the wiring in the electrical schematic.
- For products connected in series, the "+" pole of one product is connected to the "-" pole of another product. Extension cables are required if the connection of products between different rows is needed.

Please use extension cables that are for solar applications specifically.

When installing, first install the conventionally installed products according to the drawings, reserve the cables for the products that need to be bridged, and do not install the products in the bridged parts. And connect the extension cord here first. Lead out the other end of the extension cable, and lead it to another location to be bridged according to the wiring diagram. Then complete the installation of the in-place product. When it is time to install the product on the other end of the jumper cable, complete the installation of the other end. (Figure 22)



**FIGURE 22 PRODUCT JUMPER CONNECTION OPERATION INSTRUCTIONS (FRONT VIEW)**

- When a group of series connections are connected the drawing, the remaining group of "+" and "-" pole terminals are connected to the combiner connector or combiner box.
- Parallel connection of all accessory strings is done at the combiner connector or combiner box.

Note: This document only describes the wiring requirements and wiring principles. Since the roof of each site may not be the same, it is not possible to make uniform wiring process for each project here. Wiring can be done later in accordance with the product installation layout drawings in each project.

## 5.7 COMBINER BOX INSTALLATION REQUIREMENTS

- Connect the convergence kit to the product array according to the electrical schematic.
- Docking plugs should be plugged in place and firmly connected.
- The convergence kit can be fixed on the bracket, and the alignment is neat and easy to maintain.
- The connection of the cable should avoid cable stress and friction due to wind-blown vibration and damage to the outer skin of the cable.

After the terminals of the convergence kit are connected, use the same cable clamps as the terminals of the product to clamp up the ends of the terminals.

# 6

## ELECTRICAL CONSTRUCTION PROCESS

### 6.1 OPERATING CONDITIONS

- Assembly of product array is completed.
- Installation of inverter and distribution box is completed.

### 6.2 PREPARATION OF MAIN TOOLS

- Impact drill: For drilling holes in the installation position of PVC and other line pipes and pipe cards.
- crimper: For on-site DC cable splice plug production.
- Multimeter, megohmmeter: For cable conduction and insulation testing.
- Wire stripping pliers: For cable stripping.

### 6.3 MAIN MATERIALS

- DC cables for photovoltaics.

- AC cables.
- Cable DC connectors use the same type of the product or a compatible one which satisfy local standards and requirements.

#### 6.4 INSTALLATION ENGINEERING PROCESS

Determine the cable run and AC/DC conduit requirement after on-site measurement.

- Conduit is required for cables between the array and inverter.
- Conduit is required for cables between the inverter and distribution box, distribution box and household electricity box.

#### 6.5 CONDUIT LAYING REQUIREMENTS

- When laying electrical conduits on the wall, they should be laid in the corners of the wall, in the same direction as rainfall pipes and air-conditioning pipes.
- It is advisable to avoid the crossover of AC and DC directions in the piping between equipment.

#### 6.6 CABLE LAYING

Requirements for cable laying:

- When wiring each system, the type of conductor, voltage level, etc. are inspected according to the provisions of the current national standards.
- Remove water and debris from the conduit or wire channel before threading.
- When using the crimping method to connect the wire, the specifications of the terminal copper sleeve crimp should be consistent with the cross-section of the cable core.
- ① AC and DC cables should be run in different conduits to ensure safety.
- ② After the cable is installed, the joints should be glued and sealed to prevent water from seeping into the conduit. The opening of exposed conduits should be plugged in with a soft cloth to avoid the entry of foreign objects.
- Cable bending radius  $\geq 6D$ .
- Wiring through conduits to avoid high temperature heat generating objects as much as possible.
- Conduits need to be secured by conduit clips.
- The AC and DC cables connected to the inverter and distribution box should be marked with the cable number at both ends.

DC side cable connector installation:

- Arrange cable connectors and pins according to their intended polarity.
- Strip the DC PV cable by using wire strippers according to the length of the copper core pins.
- Insert the DC PV cable into the pins, and crimp the pins.
- Insert the pins into the male and female connectors and fasten them with the special screwdriver.

- Plug in the male and female cable connectors and test the tightness of the connection.

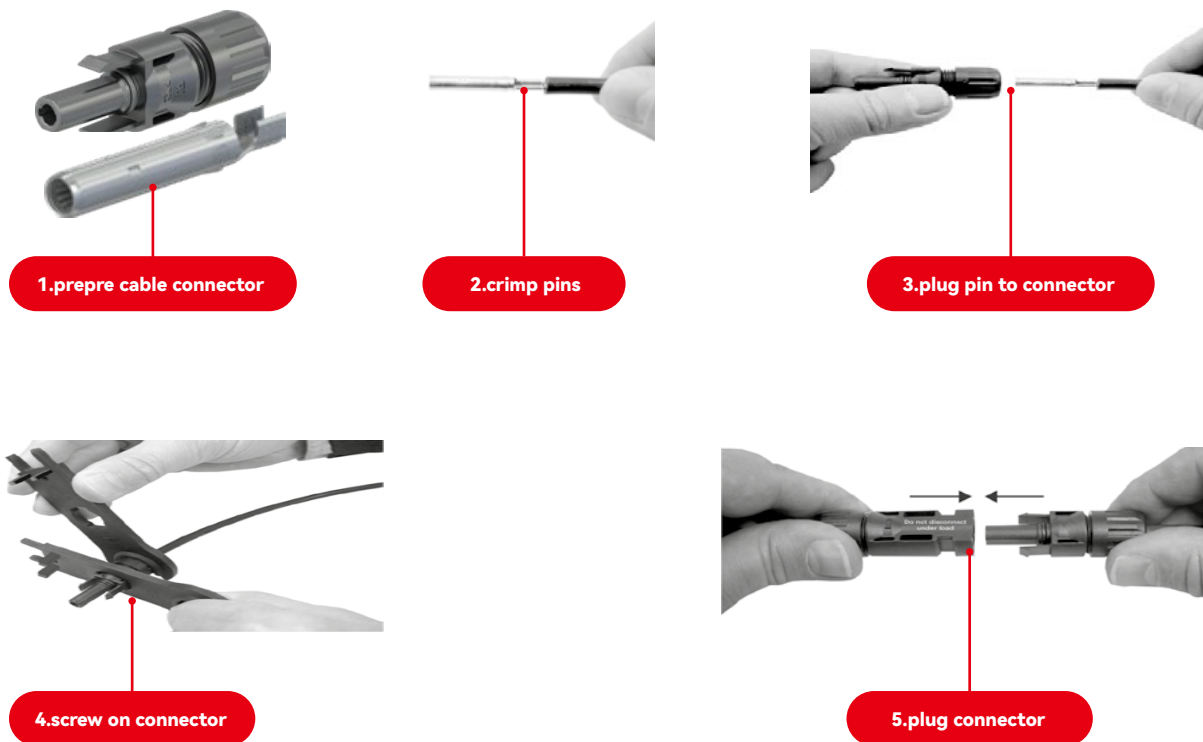

**FIGURE 23 CABLE CONNECTOR PRODUCTION METHOD**

## 6.7 SUB-PROJECT REQUIREMENTS

- PVC flame-retardant rigid plastic pipe and its attached oxygen index should be 27% or more.
- Insulation of the cables should be tested before being threaded into conduits.
- The minimum allowable bending radius of the cable laid through the pipe is six times of cable diameter.
- The conduit clip spacing of exposed conduits should be:
  - ① 20 pipes are laid openly along the wall with a maximum distance of 1.5m between pipe clips;
  - ② 25 pipes are laid openly along the wall with a maximum distance of 2m between pipe clips.
  - ③ Allowable value of deviation for the laying of open piping.

Straightness	<1.5mm/m
Verticality	<1.5mm/m

- Cables from different circuits, different voltages or AC and DC cables, should not be worn in the same conduit.
- There shall be no joints in the wires in the conduits.
- Connect the plugs tightly.

## 7

## OPERATION AND MAINTENANCE

Products require regular inspection and maintenance, especially during the warranty period. To ensure optimum performance, GOODWE recommends the following measures:

**Visual Inspection:**

Visual inspection of the product for damage or other conspicuous features, focusing on the following:

- Whether the glass of the product is broken.
- Whether corrosion has occurred near the fingers of cell, which is caused by water vapour entering the product due to breakage of the surface encapsulation material during installation or transport.
- Whether the back plate of the product has broken.
- Whether the product has signs of aging, including animal damage, weathering, corrosion and whether the connection of connectors is tight and whether the products are well grounded.
- The surface of the product should not be touched with sharp objects;
- The products should not be shaded;
- Whether there is any loosening or damage to the fixing of the product to the purlin or the base. Please make timely adjustments or repair if any damage is identified.

**Cleaning**

- Dust and dirt on the surface of the product will reduce the power output. GOODWE recommends using a sponge or soft cloth containing water to wipe the glass surface and strictly forbids the use of cleaning agents containing acids or alkalis to clean the product.
- Please remove snow and ice without force. Please use a soft broom in order not to damage the protective layer of the product.
- Do not use rough and sharp tools to clean products.
- To reduce potential electric shock or burns, GOODWE recommends cleaning the product in the early morning or late evening when there are low irradiation levels and low temperatures.
- Do not clean products with broken glass or back plates, exposed wires or broken features to avoid the risk of electric shock.
- Always wear rubber gloves whilst servicing, washing, or cleaning the modules and pay attention to the connection of cables and electrics.

**Connectors and Cable Connections**

It is recommended to carry out a preventative inspection every 6 months

- Check whether the junction box sealant has cracks or gaps.
- Check whether the connectors are sealed and the cable connections are secure.



## 8

## CAUTIONS

The following maintenance measures are recommended to ensure that the products achieve optimum performance and maximum system power generation.

**Visual Inspection:**

Product appearance inspection focuses on the following:

- Whether the product is damaged or not.
- Whether sharp objects are touching the surface of the product.
- Whether the product is shaded by obstacles and foreign objects, newly grown trees, newly erected poles, etc.
- Whether there is corrosion near the cell grid wire.

**Product cleaning.**

The accumulation of dust or dirt on the surface of the product will reduce the power output. It should be cleaned regularly to keep the surface clean, and generally should be cleaned at least once a month. Cleaning frequency should be adjusted depending on the local environment.

Please note the following when cleaning photovoltaic products:

- Make sure the products and cables are not broken before cleaning the product.
- First rinse the product with clean water, and then wipe the water stains dry with a soft cloth, it is strictly prohibited to use corrosive solvents to clean or wipe PV products with hard objects.
- PV products should be cleaned at irradiance below 200W/m<sup>2</sup>, preferably when there is no sunlight or in the morning and evening.
- It is strictly forbidden to wash PV products during strong wind (wind force greater than 4), heavy rain or heavy snow.

Attention: Do not walk, stand, or sit on the product for product cleaning.

- Product connector and cable inspection.

It is recommended to inspect them every six months in a preventive manner.

Inspect PV products for signs of aging. This includes possible rodent damage, weather aging, and that all connectors are tightly connected and free of corrosion.

Do not disassemble the product by yourself if it is damaged, please inform the professional to handle it.

- All electrical installations must comply with electrical installation standards and be completed by an electrical professional. Ensure that all input and output switches are off.
- Do not connect the DC cable to the inverter AC output socket, and do not short-circuit or ground the output circuit.
- The cable route between the DC input and the inverter should be as short as possible.
- Different colour cables should be selected to differentiate the connection process. The

positive terminal is connected to the red cable and the negative terminal is connected to the blue cable.

- To ensure a balance between the product strings, the selected DC cables should have the same cross-sectional area.
- Make sure to cover the product with an opaque material or disconnect the DC side circuit breaker before making electrical connections. The product array will generate dangerous voltages when exposed to sunlight.

#### **MANUFACTURER**

GOODWE POWER SUPPLY TECHNOLOGY CO.,  
No.208, Tong Rui East Road, Guangde, Anhui, P.R. China  
Made in China

GOODWE POWER SUPPLY TECHNOLOGY CO., LTD  
No.208 Tongrui Rd., EDZ, Guangde, Anhui, China.  
Made in China.